











Figure similar

General technical data:		
product brandname		SIRIUS
Product designation		mechanical RESET
Design of the product		resetting plunger, holder and funnel
Size of overload relay		S00, S0
Ambient temperature		
• during storage	°C	-50 ... +80
• during operation	°C	-20 ... +70

Certificates/ approvals:

General Product Approval	Declaration of Conformity	Test Certificates	Shipping Approval
 CSA	 UL	 EG-Konf.	<a href="#">Type Test Certificates/Test Report</a>  ABS  BUREAU VERITAS

Shipping Approval	other
 PRS  RINA  RMRS	<a href="#">Environmental Confirmations</a> <a href="#">Confirmation</a>

### Further information

**Information- and Downloadcenter (Catalogs, Brochures,...)**

<http://www.siemens.com/industrial-controls/catalogs>

**Industry Mall (Online ordering system)**

<http://www.siemens.com/industrymall>

**Cax online generator**

<http://support.automation.siemens.com/WW/CAXorder/default.aspx?lang=en&mlfb=3RU2900-1A>

**Service&Support (Manuals, Certificates, Characteristics, FAQs,...)**

<https://support.industry.siemens.com/cs/ww/en/ps/3RU2900-1A>

**Image database (product images, 2D dimension drawings, 3D models, device circuit diagrams, EPLAN macros, ...)**

[http://www.automation.siemens.com/bilddb/cax\\_de.aspx?mlfb=3RU2900-1A&lang=en](http://www.automation.siemens.com/bilddb/cax_de.aspx?mlfb=3RU2900-1A&lang=en)

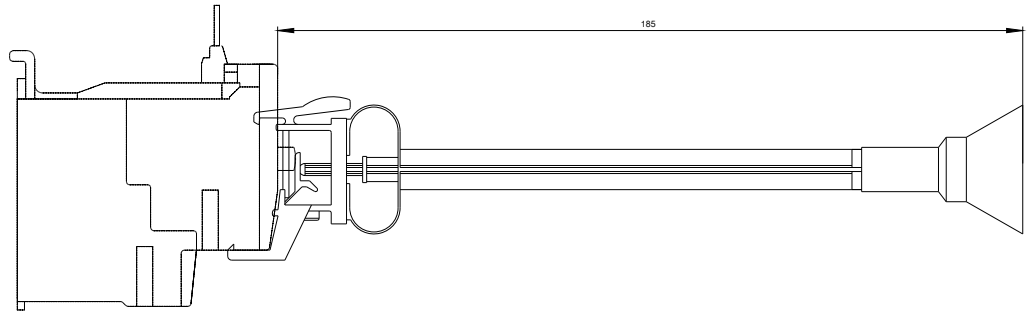
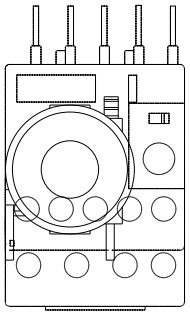

last modified:

07/01/2017